

# VINCENT SHEPPARD



## ODA COLLECTION

PRODUCT DATA SHEET

ODA COLLECTION



DINING CHAIR



ODA LOUNGE CHAIR



ODA LOUNGE SOFA 2.5S



ODA LOUNGE SOFA 3S



SUNLOUNGER

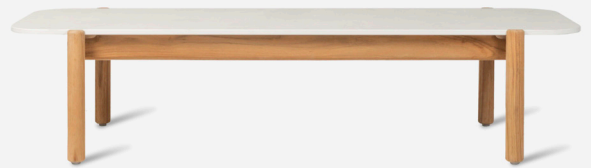

ODA SIDE TABLE 45



ODA COFFEE TABLE 68



ODA SIDE TABLE 45



ODA COFFEE TABLE 90

**ODA**

<b>frame</b>	teak
<b>frame finish</b>	untreated teak
<b>straps</b>	polypropylene
<b>strap color</b>	flax
<b>top</b>	ceramic
<b>top color</b>	portland
<b>glides</b>	nylon

**CUSHION**

<b>foam</b>	lounge: 14 cm quick dry foam
<b>removable</b>	yes
<b>fabrics</b>	see <a href="#">fabric data sheet</a> for more info

**COLOURS**



**PROTECTIVE COVERS**

We recommend using protective covers only on **dry** furniture.

<b>lounge chair</b>	PC002
<b>lounge sofa 2.5S</b>	PC003
<b>lounge sofa 3S</b>	PC043
<b>sunlounger</b>	PC022

**DIMENSIONS**

**DINING CHAIR**

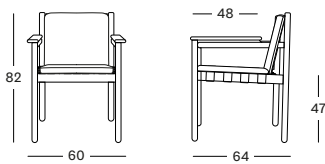

**LOUNGE CHAIR**

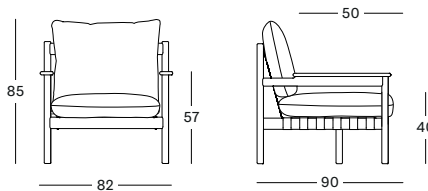

**LOUNGE SOFA 2,5S**

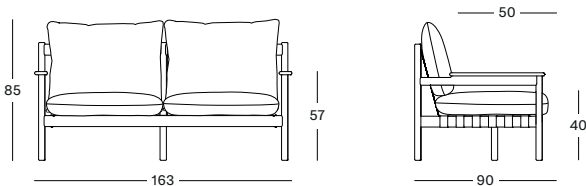

**LOUNGE SOFA 3S**

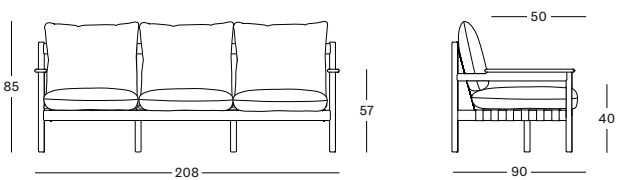

**SUNLOUNGER**

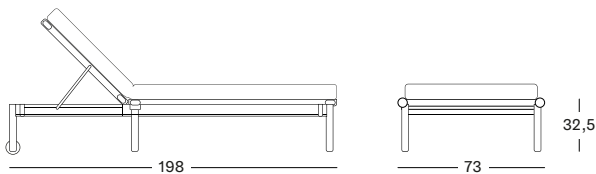

**COFFEE & SIDE TABLES**

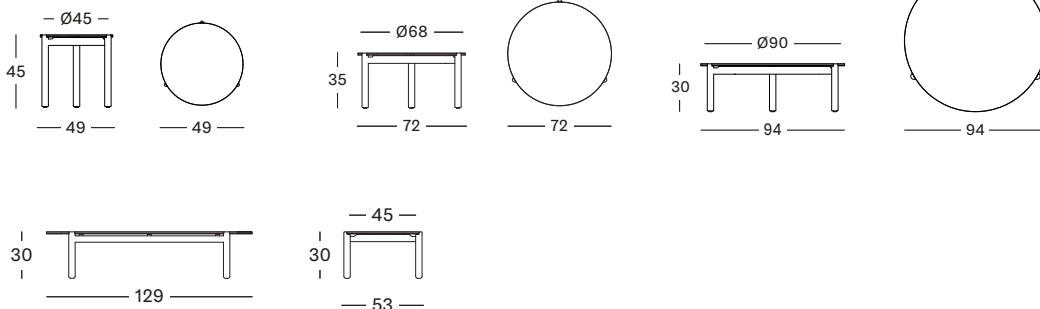

**IN THIS COLLECTION**

ODA	ITEM CODE	FINISH	PACKAGE DIMENSION (cm/inch)		CBM (m <sup>3</sup> /ft <sup>3</sup> )		Weight (kg/lb)	
dining chair	GD021W002S047	untreated teak/flax	62 x 67 x 86	24 x 26 x 34	0,357	12,61	10,1	22,27
lounge chair	GC200W002S047	untreated teak/flax	87 x 85 x 79	34 x 33 x 31	0,58	20,48	12,37	27,27
lounge sofa 2.5S	GC201W002S047	untreated teak/flax	165 x 84 x 79	65 x 33 x 31	1,09	38,49	17,4	38,36
lounge sofa 3S	GC202W002S047	untreated teak/flax	210 x 84 x 79	82 x 33 x 31	1,39	49,09	21,28	46,92
sunlounger	GC016W002S047	untreated teak/flax	204 x 79 x 40	80 x 31 x 16	0,645	22,78	34,34	75,7
side table dia 45	GT149W002K001	untreated teak/ ceramic flint	41 x 46 x 48	16 x 18 x 19	0,09	3,18	10	22
side table dia 45	GT149W002K002	untreated teak/ ceramic shards	41 x 46 x 48	16 x 18 x 19	0,09	3,18	10	22
side table dia 45	GT149W002K003	untreated teak/ ceramic portland	41 x 46 x 48	16 x 18 x 19	0,09	3,18	10	22
coffee table dia 68	GT150W002K001	untreated teak/ ceramic flint	58 x 66 x 38	23 x 26 x 15	0,15	5,30	19	42
coffee table dia 68	GT150W002K002	untreated teak/ ceramic shards	58 x 66 x 38	23 x 26 x 15	0,15	5,30	19	42
coffee table dia 68	GT150W002K003	untreated teak/ portland	58 x 66 x 38	23 x 26 x 15	0,15	5,30	19	42
coffee table dia 90	GT151W002K001	untreated teak/ ceramic flint	75 x 85 x 33	30 x 33 x 13	0,21	7,42	30	66
coffee table dia 90	GT151W002K002	untreated teak/ ceramic shards	75 x 85 x 33	30 x 33 x 13	0,21	7,42	30	66
coffee table dia 90	GT151W002K003	untreated teak/ portland	75 x 85 x 33	30 x 33 x 13	0,21	7,42	30	66
coffee table 129x53	GT147W002K001	untreated teak/ ceramic flint	103 x 51 x 33	41 x 21 x 13	0,17	6	25,1	55,34
coffee table 129x53	GT147W002K002	untreated teak/ ceramic shards	103 x 51 x 33	41 x 21 x 13	0,17	6	25,1	55,34
coffee table 129x53	GT147W002K003	untreated teak/ portland	103 x 51 x 33	41 x 21 x 13	0,17	6	25,1	55,34

## MAINTENANCE AND CARE

---

### TEAK

#### Daily care

Use a moist towel or sponge with a mild solution of water and natural, non-aggressive soap.

#### Stubborn stains

If your furniture is stained, consider one of the following options:

- **Grease spots have appeared on the furniture**

This is a natural feature of the wood and grease spots should gradually disappear after being exposed to sunlight. However, should you wish to remove these blemishes, we recommend using a degreasing agent and gentle scrubbing with a brush. Rinse off with clean water.

- **The furniture has developed mildew spots or black blemishes**

This is usually the result of rainwater or sometimes sap dripping from the leaves of trees onto the wood leaving dark marks and spots. Ideally, we recommend the furniture is not placed under trees. However, these marks can be removed by lightly sanding with fine sandpaper.

- **You spilled wine or something else leaving persistent stains**

For wine and other stains, we recommend using a weak solution of bleach and water combined with a dishwashing agent to wipe the area clean.

### CERAMIC

If you're looking for a material which requires little to no maintenance, yet offers maximum resistance, you would do well to involve ceramic. The material preserves the natural look of stone and offers top of the chart convenience. Cleaning the table with water and mild soap will do the trick!

### POLYPROPYLENE STRAP

Another material used for our all-weather furniture, is rope. Our rope is made of polypropylene fibres or acrylic. Just like our other synthetic materials, the rope is designed to withstand any weather condition and can be left outside all year long.

For maintaining your rope furniture, we recommend using a fabric and upholstery protector to give optimal stain resistance.

To clean spots on the rope, we suggest applying a mist of soapy water with a spray bottle and then work the solution into the rope with a soft cloth by patting or rubbing lightly. Rinse the solution thoroughly and then blot excess moisture from the rope using a soft cloth and allow air-drying.

Never use a high-pressure hose on acrylic rope.